

Technical Specifications / Engineering Submittals

Raritan Model Number: PX3-3211

rev20171011

LINE DRAWING

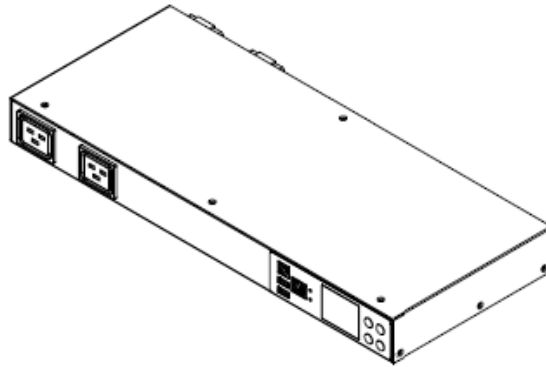

FEATURES

Energy Metering	Voltage (V), Current (A), Active Power (kW), Real Power (kVA), Energy (kWh), Power Factor
Metering Accuracy	ISO/IEC 62053-21 1%
Metering per Input Line	Yes
Metering per Branch Circuit Breaker	No
Metering per Output Receptacle	No
Remote Outlet Switching	No
Environmental Sensor Ready	Yes
Replaceable Controller	No
Compatible Sensors	Temperature, Humidity, Air Flow, Differential Pressure, Water Leak, and Contact Closure
Networking	Gigabit (10/100/1000 BaseT) Ethernet port; secondary, redundant (10/100 BaseT) Ethernet port. Optional WiFi (802.11a/b/g/n)
Remote Management	HTTP(s); SSH; Telnet; RS-232 (Serial); Power IQ; SNMP version v2/v3; SMTP; JSON-RPC
Cascading	Yes, Max 16 PDUs can be daisy chained using a single Ethernet or USB connection
Onboard Display	Color, matrix LCD display : Voltage, current, or active power (per line); Alarms; Configuration information (name, ratings, IP / Networking information)
Embedded Processor	ARM Cortex A5 536MHZ (Atmel A5D35A), 16MB SPI Flash, 64MB DDR2 RAM

Technical Specifications / Engineering Submittals

Raritan Model Number: PX3-3211

rev20171011

INPUT

Input Plug	IEC 60320 C20 (2P3W)
Cord Length	3 meters (9.84 feet) standard
Cord Entry	Rear feed
Cable Type	IP44("splashproof")
Number of Power Cords	2
Maximum Input Current	16A
Nominal Input Voltage	230V
Rated Input Voltage	100 - 240V
Input Frequency	50/60Hz
Power Capacity	0.0kVA at 100V, 0.0kVA at 240V

OUTPUT

Nominal Output Voltage	230V
Rated Output Voltage	100 - 240V
Receptacles (Output Connections)	(2) IEC320 C19, 16A
Securelock Support	Yes
Cord Retention	No
Overload Protection	N/A

PHYSICAL

Color	Black powder coat (custom colors available)
Unit Dimensions (WxDxH)	17.3" x 7.2" x 1.7" ; 440mm x 183mm x 44mm
Unit Weight	3.2 kg
Shipping Weight	5.05 kg
Shipping Dimensions (WxDxH)	17.2" x 13.98" x 22.83" ; 437mm x 355mm x 580mm
Mounting	Tool-less button mount

Technical Specifications / Engineering Submittals

Raritan Model Number: PX3-3211

rev20171011

ENVIRONMENTAL

Operating Temperature 60°C

Operating Relative Humidity 85%

Operating Elevation 0-10000ft

CONFORMANCE

Regulatory Approvals CE, Canada ICES-003, Part 15 Class A of the FCC rules,
RoHS compliant

Warranty Standard 2 years manufacturer warranty

Technical Specifications / Engineering Submittals

Raritan Model Number: PX3-3211

rev20171011

CONTROL PANEL

Dimension: 69.7x40mm

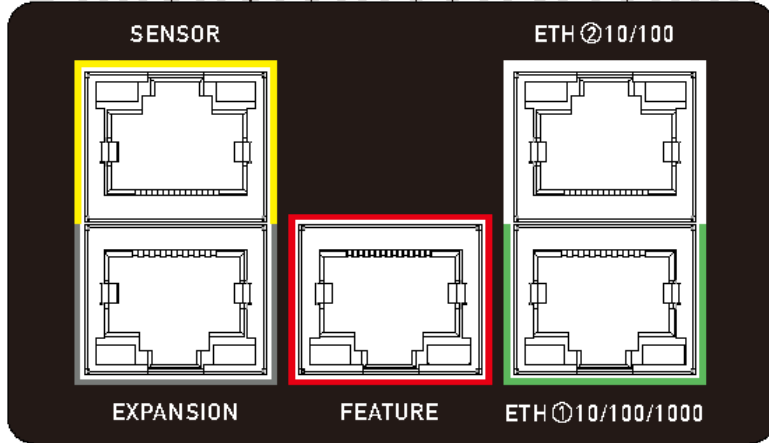

CONTROL PANEL2

Dimension: 139x40mm



Technical Specifications / Engineering Submittals

Raritan Model Number: PX3-3211

rev20171011

ELECTRICAL (ONE LINE) DIAGRAM

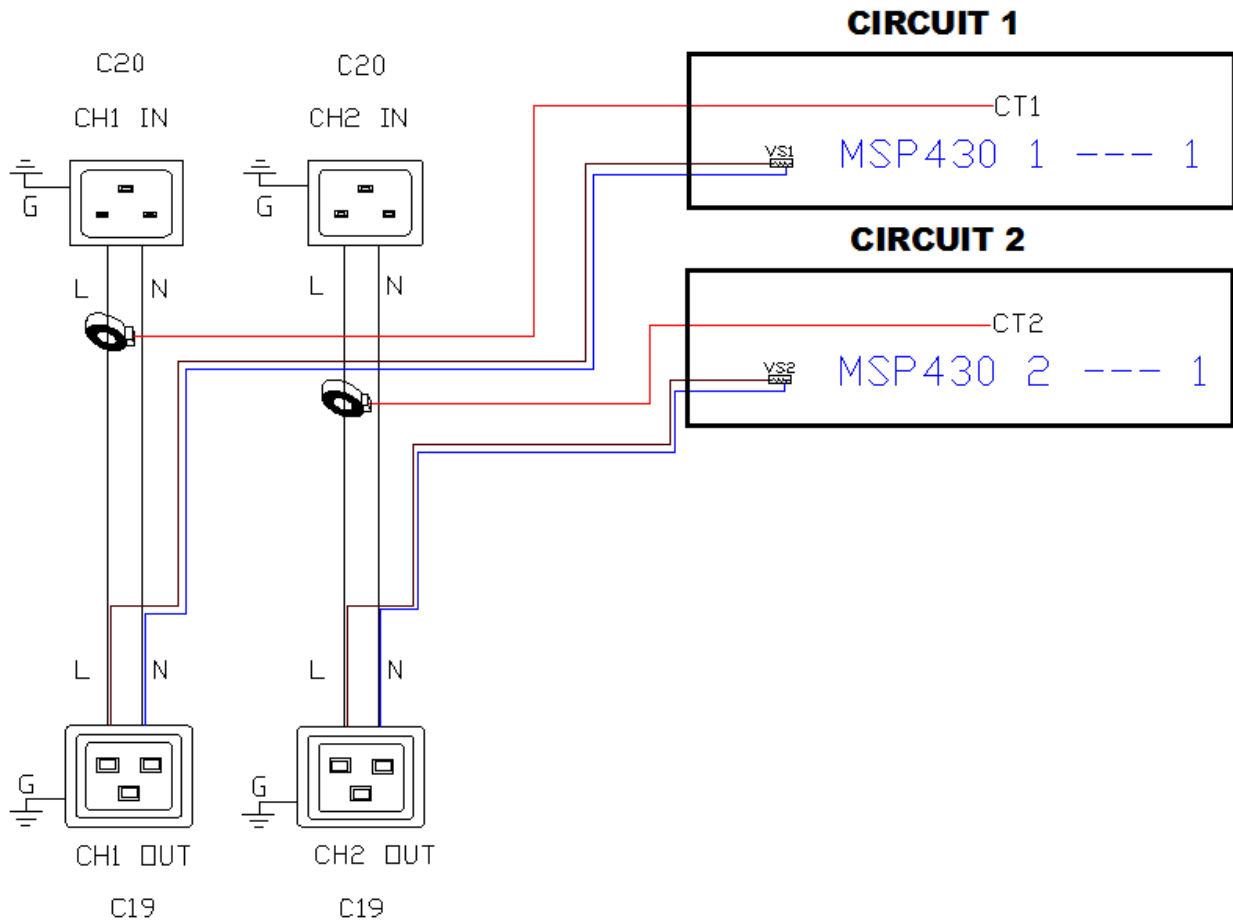

Technical Specifications / Engineering Submittals

Raritan Model Number: PX3-3211

rev20171011

MECHANICAL DIAGRAM

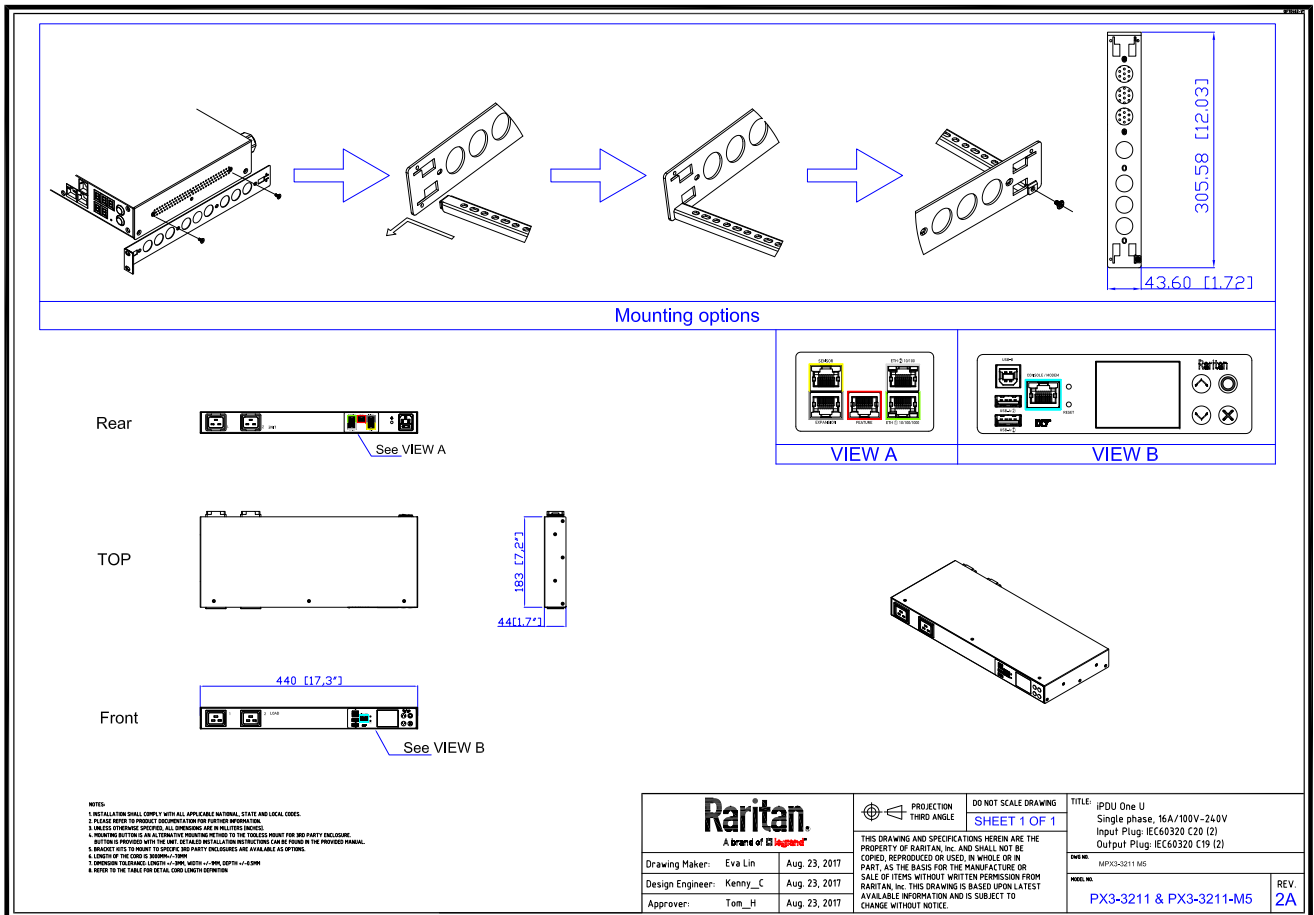

Technical Specifications / Engineering Submittals

Raritan Model Number: PX3-3211

rev20171011

TRIP CURVE

This file generated on: Wed, October 11, 2017 - 01:50:22