

Technical Specifications / Engineering Submittals

Raritan Model Number: PX3-5466R

rev20171206

LINE DRAWING

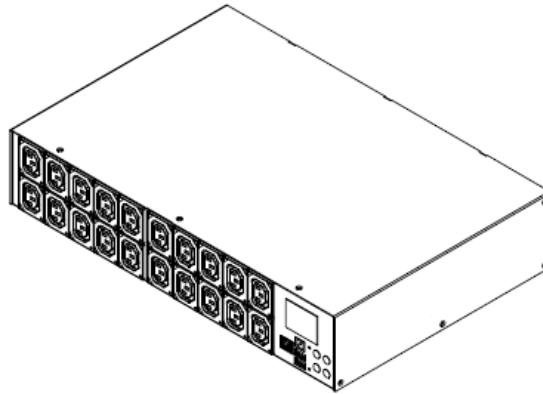

FEATURES

Energy Metering	Voltage (V), Current (A), Active Power (kW), Real Power (kVA), Energy (kWh), Power Factor
Metering Accuracy	ISO/IEC 62053-21 1%
Metering per Input Line	Yes
Metering per Branch Circuit Breaker	Yes
Metering per Output Receptacle	Yes
Remote Outlet Switching	Yes
Environmental Sensor Ready	Yes
Replaceable Controller	No
Compatible Sensors	Temperature, Humidity, Air Flow, Differential Pressure, Water Leak, and Contact Closure
Networking	Gigabit (10/100/1000 BaseT) Ethernet port; secondary, redundant (10/100 BaseT) Ethernet port. Optional WiFi (802.11a/b/g/n)
Remote Management	HTTP(s); SSH; Telnet; RS-232 (Serial); Power IQ; SNMP version v2/v3; SMTP; JSON-RPC
Cascading	Yes, Max 16 PDUs can be daisy chained using a single Ethernet or USB connection
Onboard Display	Color, matrix LCD display : Voltage, current, or active power (per line, per breaker, or per receptacle / outlet); Alarms; Configuration information (name, ratings, IP / Networking information)
Embedded Processor	ARM Cortex A5 536MHZ (Atmel A5D35A), 16MB SPI Flash, 64MB DDR2 RAM

Technical Specifications / Engineering Submittals

Raritan Model Number: PX3-5466R

rev20171206

INPUT

Input Plug	IEC 60309 2P+E 6h 32A (2P3W)
Cord Length	3 meters (9.84 feet) standard
Cord Entry	Rear feed
Cable Type	IP44("splashproof")
Number of Power Cords	1
Maximum Input Current	32A
Nominal Input Voltage	230V
Rated Input Voltage	200 - 240V
Input Frequency	50/60Hz
Power Capacity	6.4kVA at 200V, 7.7kVA at 240V

OUTPUT

Nominal Output Voltage	230V
Rated Output Voltage	200 - 240V
Receptacles (Output Connections)	(20) IEC320 C13, 10A
Securelock Support	Yes
Cord Retention	No
Overload Protection	(2) Airpax LEGBX6-37483-16-V

PHYSICAL

Color	Black powder coat (custom colors available)
Unit Dimensions (WxDxH)	17.3" x 11.5" x 3.5" ; 440mm x 293mm x 88mm
Unit Weight	6.8 kg
Shipping Weight	10.8 kg
Shipping Dimensions (WxDxH)	21.73" x 11.18" x 22.05" ; 552mm x 284mm x 560mm
Mounting	RACK-KIT-PX-2U

Technical Specifications / Engineering Submittals

Raritan Model Number: PX3-5466R

rev20171206

ENVIRONMENTAL

Operating Temperature	60°C
Operating Relative Humidity	85%
Operating Elevation	0-10000ft

CONFORMANCE

Regulatory Approvals	CE, Canada ICES-003, Part 15 Class A of the FCC rules, RoHS compliant
Warranty	Standard 2 years manufacturer warranty

Technical Specifications / Engineering Submittals
Raritan Model Number: PX3-5466R

rev20171206

CONTROL PANEL

Dimension: 69.7x40mm

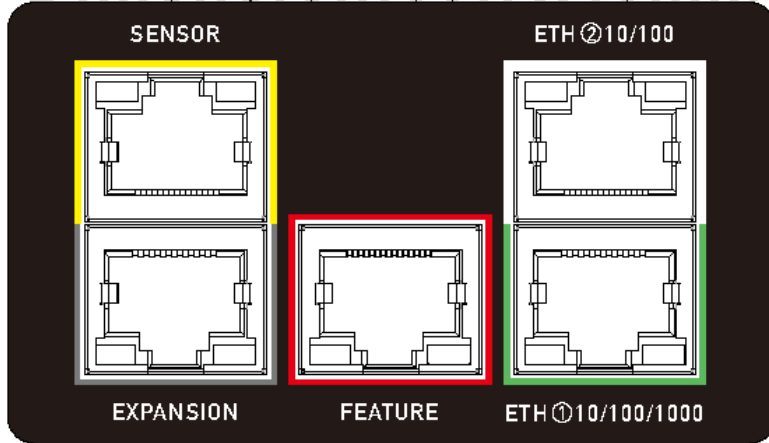

CONTROL PANEL2

Dimension: 77.6x81mm

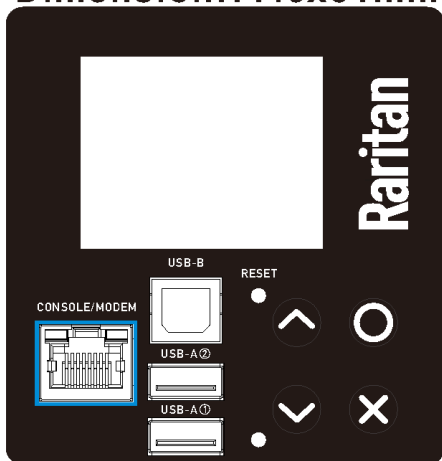

Technical Specifications / Engineering Submittals

Raritan Model Number: PX3-5466R

rev20171206

ELECTRICAL (ONE LINE) DIAGRAM

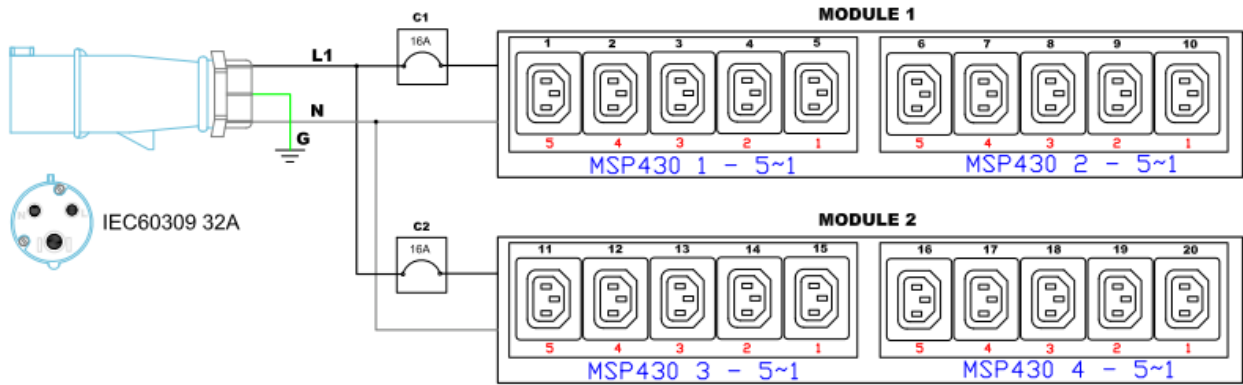

Technical Specifications / Engineering Submittals

Raritan Model Number: PX3-5466R

rev20171206

MECHANICAL DIAGRAM

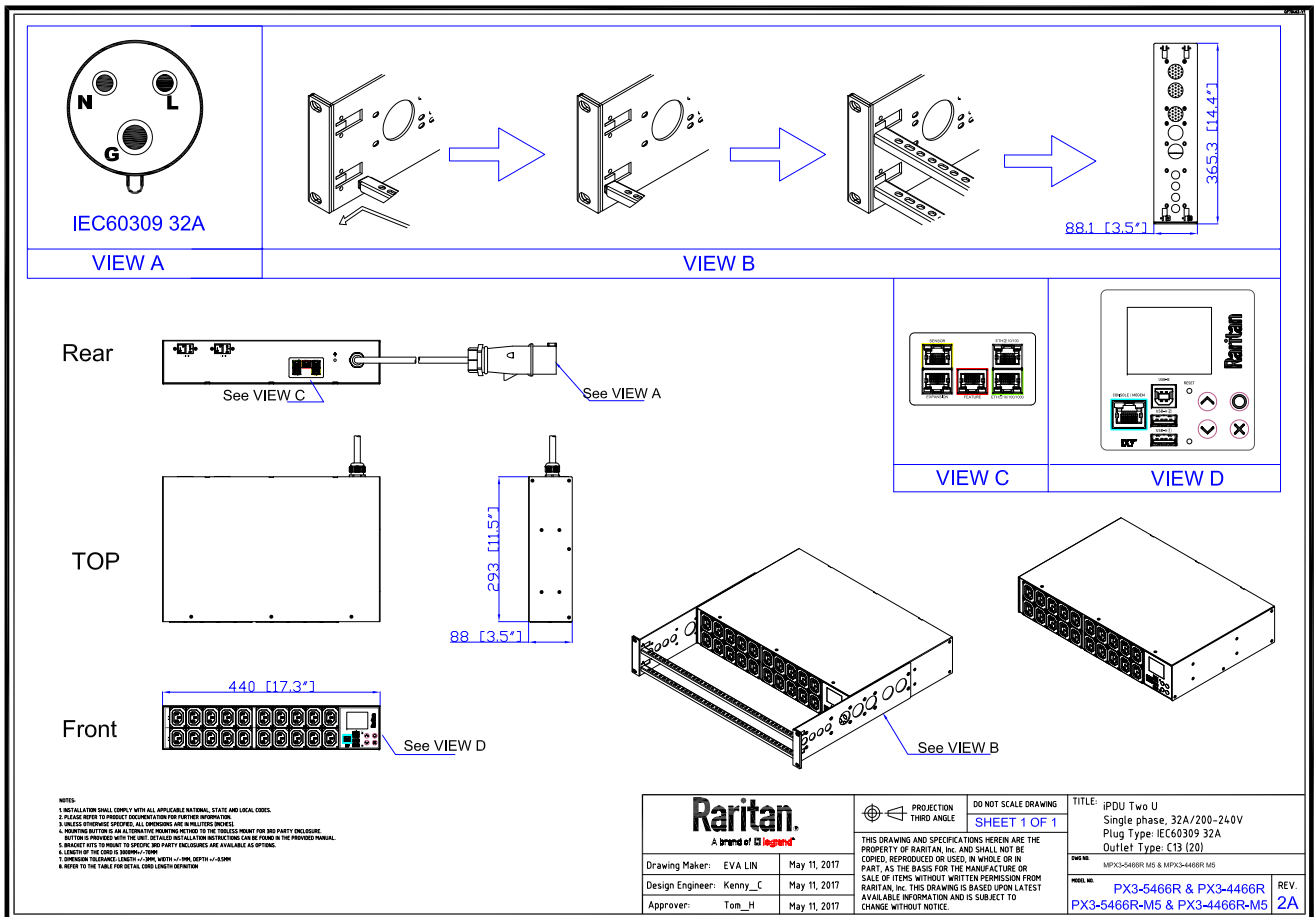

Technical Specifications / Engineering Submittals
Raritan Model Number: PX3-5466R

rev20171206

TRIP CURVE

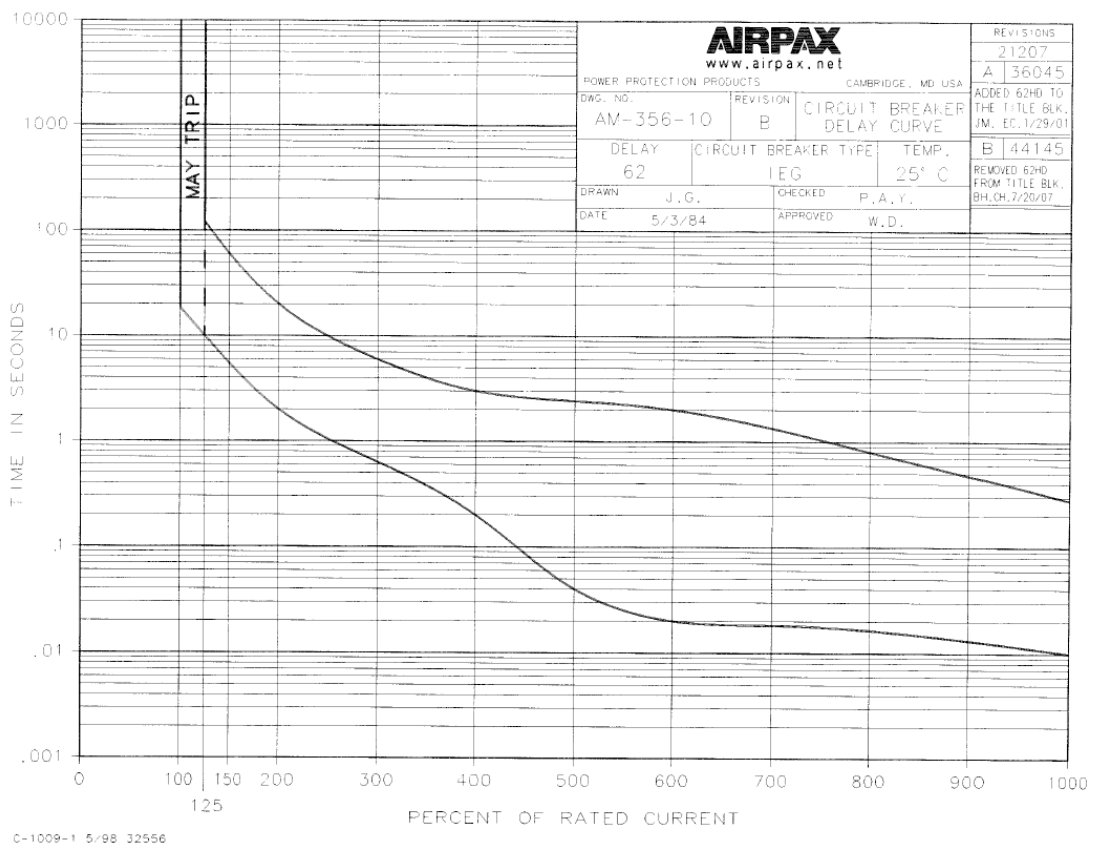

7